

## RHR-MBUS Room Humidity and Temperature Sensors / Controllers with M-Bus (Meter Bus)

The RHR-MBUS sensors are designed to measure relative humidity and temperature in the room spaces and have built-in unique M-Bus communication interface. The RHR sensors have linear 0..10V signals outputs relating to temperature, and humidity. The sensors can be used in various building automation control applications.

The RHR-MBUS sensors can be installed on a wall surface or on a wall mounting box in dry indoor environment. The RHR sensors come with a number of options such as display, active setpoint via push buttons and extra digital/resistive inputs. The RHR-MBUS resistive and digital inputs can be used for integrating local measurements such as window contacts or external temperature sensors.

The RHR-MBUS sensors can also operate as Temperature and/or Humidity controllers offering single enclosure measurement and control solutions.



Model Type	Model	Description
	<b>RHR-MBUS</b>	RHR Room Humidity and Temperature Sensor with M-Bus Communication, 1 DI, 1RI, 3AO (0..10Vdc), 2DO
	<b>-LCD</b>	Display Option
	<b>-SPB</b>	Active Setpoint Push Button Option <i>See Note 2</i>
	<b>-PB</b>	Push Button Interface Option with Timer
	<b>-PB2</b>	2 Momentary Push Buttons with Timer
	<b>-DI2</b>	Digital Input Option for 2 Digital Inputs
	<b>-RI2</b>	Resistive Input Option for 2 Resistive Inputs
Accessories	Model	Description
	<b>SW-DCT-USB</b>	Windows Device Configuration Tool Software with Serial USB Interface, 1.8m USB Lead

*Note 1. -SPB and -PB/PB2 options cannot be fitted at the same time.*

### Order Codes

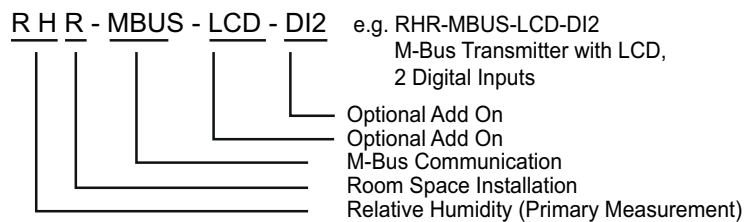

### Technical Data

Power Supply	Power supply	24Vac/dc -10%/+15%, max 1VA
Displays and Interfaces	Option -LCD	LCD Display for Showing Temperature, Humidity (configurable through the tool)

	Option -SPB	Setpoint with 2 Push Buttons (network or control; adjustable min/max limits) <b>Note: If this option is selected PB/PB2 options are no longer available. Please also select/order LCD option to visualise the setpoint.</b>
	Option -PB	Push Button with Delay Timer; status available through DO1, DO2 or via Network
	Option -PB2	2 x Push Buttons with Delay Timer; status available through DO1, DO2 or via Network
Signal Outputs	Analogue Outputs	3 x 0..10Vdc < 5mA; 100k min impedance for 1% accuracy
	Digital Outputs	2 x 24Vac 2A Triac; requires 24Vac Power Supply (DO1 & DO2)
	Option -PB (Push Button)	DO1 or DO2 configurable as 24Vac Triac; requires 24Vac Power Supply
Signal Inputs	Resistive Input	1 x NTC10/Resistive Input, 0..50kOhms (network value)
	Digital Input	1 x Digital Input, Volt-Free Contact, Impedance <10KOhm Pulse Counting: Max 25Hz, Min Pulse Length 20mA (Volatile)
	Option -RI2	Additional NTC10/Resistive Input, in total 2 x NTC10/Resistive Inputs, 0..50kOhms (network values; NTC10 default)
	Option -DI2	Additional Digital Input, in total 2 x Digital Inputs, Volt-Free Contacts (network values), Impedance <10KOhm Pulse Counting: Max 25Hz, Min Pulse Length 20mA (Volatile)
Sensing Characteristics	Humidity; Option	
	Range	0..100%rH
	Accuracy	±2% rH (within 0..90% rh)
	Technology	Auto Calibrating; Patented Non-Dispersive Infrared (NDIR)
	Non-Linearity	<1% FS
	Warm-Up Time	<20 seconds
	Response Time	2 minutes
	Temperature	
	Range	0..50°C (32..122°F)
	Accuracy	±0.3°C @ 25°C
Communication	M-Bus Communications	
	Protocol	M-Bus According to EN1434-3
	Interface	Isolated M-Bus Interface, Single 1.5mA Load
	Transmission Rates	300, 2400 and 9600 bps - selectable via a bitswitch
	Primary Addressing	1..63 via a bit switch; 1..247 via tool / network
	Secondary Addressing	Fixed and set to Product Serial Number
	Supported Commands	SND_NKE / E5, SND_UD / E5, REQ_UD2 / RSP_UD
Connections	Terminal Connections	Solid and Stranded Cable; 55° Angle for Wiring Maximum Size: 0.05 to 1.5mm <sup>2</sup> (EN ISO) / 14 to 30 AWG (UL) Rising Clamp: Size 2.5 x 1.9mm
Environmental Conditions	Operating	
	Temperature	0°C...+50°C (32..122°F)
	Humidity	0...95%rh (non-cond.)
	Storage	
	Temperature	-30°C...+70°C (-22..158°F)
	Humidity	0...95%rh (non-cond.)
Standards	CE Conformity	CE Directive 2004/108/EY EN61000-6-3: 2001 (Generic Emission) EN61000-6-1: 2001 (Generic Immunity).
	Degree of Protection	IP20
Housing	Housing Material	ABS Plastics, Self Extinguishing
	Mounting	Wall or Junction Box Mounting
	Dimensions	W86 x H120 x D29mm
	Weight	180g

**Wiring Terminals**

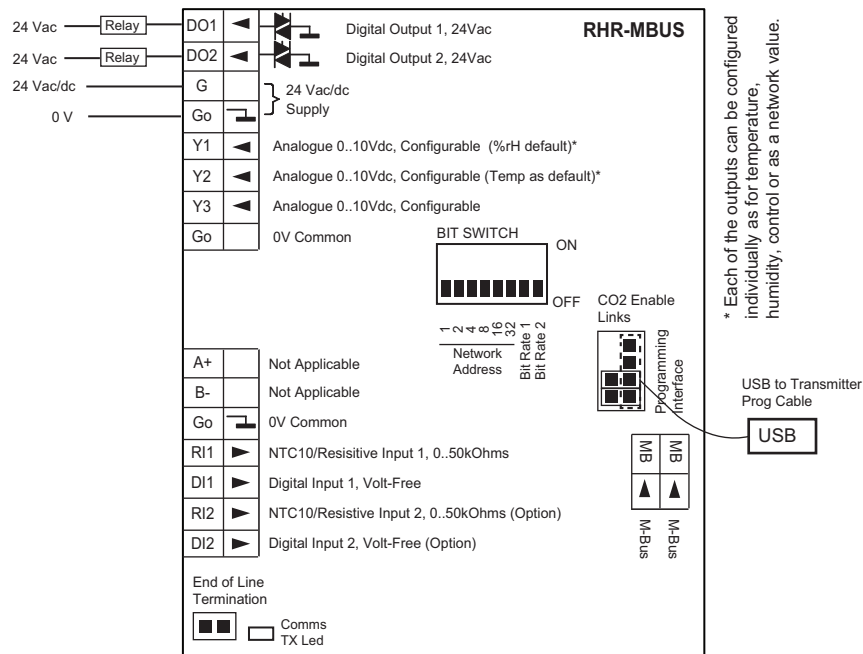

DO1	Digital Output; 24Vac Triac Switching to 0V; max. 2A
DO2	Digital Output; 24Vac Triac Switching to 0V; max. 2A
G	24Vac/dc Power Supply
G0	0V Common
Y1	0..10Vdc Analogue Output (Function Selectable)
Y2	0..10Vdc Analogue Output (Function Selectable)
Y3	0..10Vdc Analogue Output (Function Selectable)
G0	0V Common
A+	Not Applicable
B-	Not Applicable
G0	0V Common
R1	NTC10/Resistive Input 0..50kOhms
DI1	Digital Input; Volt-Free, Max 25Hz, Min Pulse Length 20mS
R12	NTC10/Resistive Input 0..50kOhms
DI2	Digital Input; Volt-Free, Max 25Hz, Min Pulse Length 20mS
MB	M-Bus Connection
MB	M-Bus Connection

**Wiring Precautions**

Switch off the power before any wiring is carried out. If the sensor has the LCD display fitted, unplug the LCD display and then wire the power supply and analogue outputs, if relevant.

After the wiring has been completed; plug-in the display and power up the sensor.

**Digital Input Pulse Counting**

Digital Inputs can be used for pulse counting up to 25Hz, minimum pulse length 20mS. The pulse count is stored in a dedicated register and can be read over the network. It is possible to write to this register to reset the value.

**NOTE: The pulse count value is not battery backed, and therefore the network master is required to manage the data synchronisation in case of power failure.**

**NTC10/ Resistive Inputs**

The resistive inputs can be configured to operate as NCT10 inputs or Resistive Inputs. As default the inputs are configured as NTC10. The maximum measurement range is -10°C to 100°C (-40°F to 212°F). The configuration is changed via the Configuration Software.

**Y1/Y2/Y3 Analogue Output Operation (Modes)**

The analogue outputs Y1/Y2/Y3 can be configured for the following options.

Output Modes	Description
Network	The output is set by the network (Modbus). On the Modbus network the actual value is configured through "Y1, Y2, Y3 Override Values" parameters, respectively.
Temperature Measurement (Default for Y2)	The output represents the temperature measurement. This is scaled over 0..10V.
Humidity Measurement	The output represents the humidity measurement. This is scaled over 0..10V.
Temperature Control	The output represents the temperature control signal.
Humidity Control (requires -RH option)	The output represents the humidity control signal.

**DO1/DO2 Digital Output Operation**

The DO1 or DO2 can be used to switch plants on/off based on a configured measurement and the setpoint (thermostatic operation). If the push button option (-PB) is fitted then DO1/DO2 can be set to switch ON when push button is pressed (delayed switch off).

Digital Output Mode Options	Description (Typical Operation)
Network	The DO1/DO2 is switched ON/OFF over the communication network.
Temperature Control Mode (e.g. Low Temperature Limit)	Reverse Mode: The DO1/DO2 is switched ON when the temperature drops below the Temperature Setpoint - Temperature Mode Hysteresis. The output is switched OFF when the temperature exceeds the Setpoint. The control direction is adjustable; reverse (heating) / direct (cooling).
Humidity Control Mode (e.g. Humidity High Limit)	Direct Mode: The DO1/DO2 is switched ON when the humidity reading exceeds the Humidity Setpoint (60% default) + Humidity Digital Output Mode Hysteresis, and switches OFF when the humidity drops below the Setpoint. The control direction is adjustable; reverse (humidification) / direct (de-humidification).
Push Button (requires -PB option)	If -PB option is fitted, it is possible to have the DO1 or DO2 on for the "Push Button Delay Time" specified in the settings after the pressing of button is detected.

**Temperature Measurement Output Scaling and Single Point Calibration**

The RHR measures the room space temperature, and the measurement can be sent to any of the analogue outputs (Y1/Y2/Y3). It is also available over the Modbus.

This output is scaled as default 0% = 0°C and 100% = 50°C). The scaling can be modified through Maximum Temperature Scaling parameter. The output can also be scaled in Fahrenheit units.

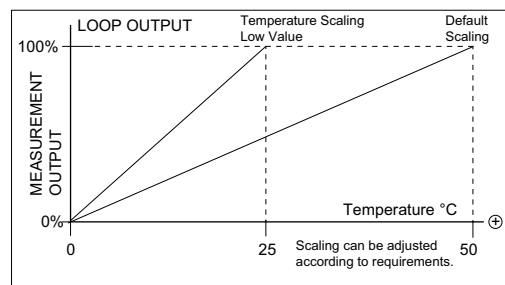

Furthermore the temperature measurement reading can be adjusted on site using the Single Point Calibration field.

**Humidity Measurement Output Scaling and Single Point Calibration**

The RHR measures the room space humidity. The humidity reading is available over the Modbus network, and the measurement can be sent to any of the analogue outputs (Y1/Y2/Y3).

This output is scaled as default 0% = 0°C and 100% = 100%rH). The scaling can be modified through Maximum Humidity Scaling parameter.

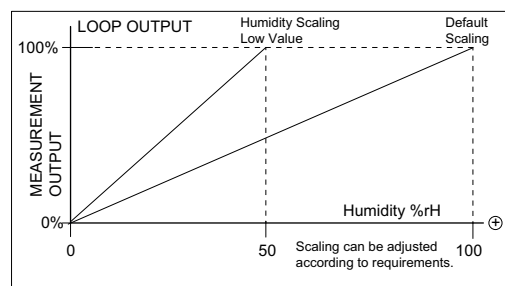

Furthermore the humidity measurement reading can be adjusted on site using the Single Point Calibration field.

**Temperature Control Loop Operation**

**Proportional or PI Control (Reverse/ Direct)**

The temperature measurement can also be used for the temperature control. The calculated control demand is then send to the output Y1, Y2 or Y3 (depending on the corresponding analogue output mode selection).

The temperature control loop output corresponds to the temperature setpoint and temperature proportional band. If configured as Reverse Control (heating), then if the temperature level drops below the setpoint the loop output starts to modulate to 100%. When the temperature is the amount of the Proportional Band below the setpoint the loop output is 100%. In the Direct Control mode the output modulates in reverse. The configuration is done via the configuration parameters.

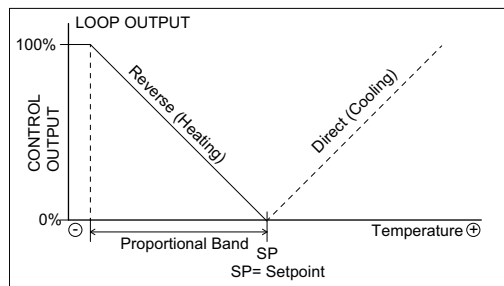

The temperature control loop can also be configured to operate as Proportional + Integral control by changing the Integral Action Time from 0 to a required value.

It is possible apply the Boost function to the control loop to override the output to 100% (see Boost Function for more details).

**Humidity Control Loop Operation Mode Selection; d**

**Proportional or Proportional + Integral Control (Reverse/ Direct)**

The humidity measurement can also be used for the humidity control. The calculated control demand is then send to the output Y1, Y2 or Y3 (depending on the corresponding analogue output mode selection).

The humidity control loop output corresponds to the humidity setpoint and the humidity proportional band. If configured as Reverse Control (humidification), then if the humidity level drops below the setpoint the loop output starts to modulate to 100%. When the humidity is the amount of the Proportional Band below the setpoint the loop output is 100%. In the Direct Control mode the output modulates in reverse. The configuration is done via the configuration parameters.

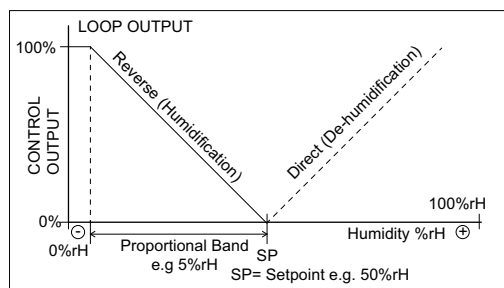

The humidity control loop can also be configured to operate as Proportional + Integral control by changing the Integral Action Time from 0 to a required value.

It is possible apply the Boost function to the control loop to override the output to 100% (see Boost Function for more details).

**Boost Function**

It is possible to boost/override any of the control outputs to 100%. This can be achieved via a push button on the device (PB-option) or via a digital input. If the Push Button is used then the control output is boosted to 100% for the amount of Push Button Delay Time. When the boost is active the Blue Push Button backlight is lit. When the digital input the output is boosted to 100% when the input is closed. When the digital input is opened the output remains 100% for the time set in the parameter Digital Input Off Delay.

**Digital Output DO1/DO2 Control Modes**

When the digital output DO1 or DO2 is configured to work in any of the control modes; Temperature Control or Humidity Control; the corresponding digital output is switched ON/OFF based on the corresponding Setpoint property and the corresponding hysteresis. The direction of the operation is also adjustable through Control Loop Operating Mode Parameter.

The diagram below illustrates the operation for Temperature Control Mode. The same concept is applicable for any of the DO1/DO2 control modes (Temperature, Humidity).

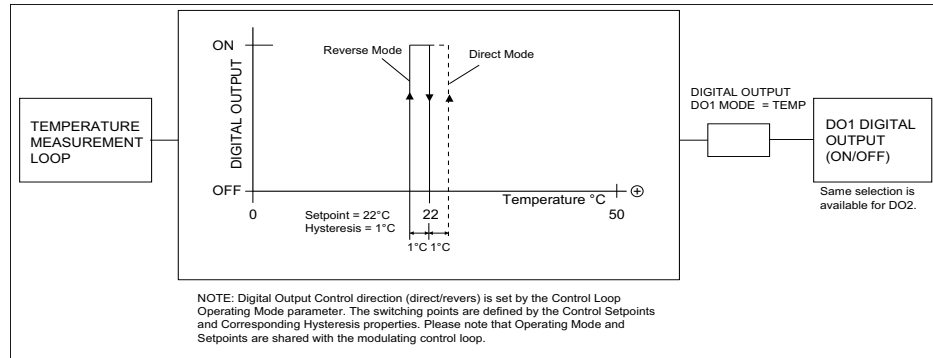

**Setpoint Knob (-SP option) or Setpoint with Push Buttons (-SPB option)**

With setpoint options it is possible to adjust the current control setpoint. The setpoint knob option provides rotary knob for the setpoint whereas the SPB option provides two push buttons for setpoint. The adjustment shifts the temperature or humidity setpoint up or down depending on the configuration parameter settings. The setpoint can also be made only to be available as a network parameter (no influence to control). In this case the value displayed is between the minimum and the maximum settings (e.g -5.0 to +5.0).

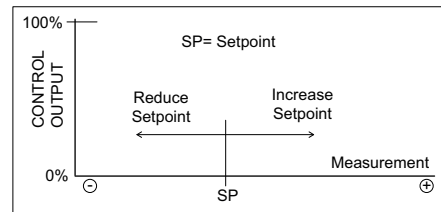

**Note: SPB option requires also -LCD option to be selected/fitted.**

**Display (Requires Option -LCD)**

The LCD display shows the temperature and humidity readings. The display has white backlight which is as default switched off. The backlight can be switched on and its intensity can be adjusted.

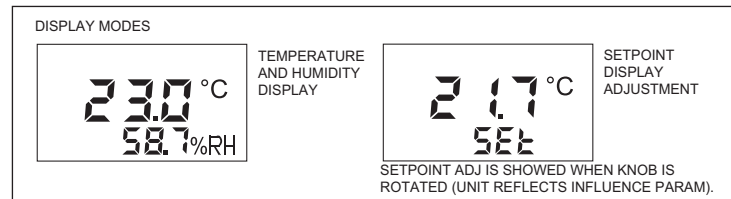

**Note: The backlight is permanently on if activated. At 50% intensity the backlight lifetime is approx 10,000 hours. After this time the LCD module needs replacing if the backlight is required. The display continues to operate without the backlight.**

**Configuration Parameters and Programming**

The parameter options can be configured using the DCT Sensor Configuration Tool software. This is connected via the PC USB cable (or via Bluetooth module) to the programming header of the transmitter as shown on the image below.

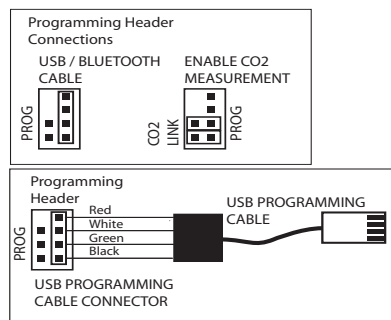

The correct process for connecting the sensor via the USB is as follows:-

- Disconnect USB Connector from PC
- Disconnect the Sensor from Power
- Plug-In the 4-Way Connector to the Sensor
- Connect the USB to the PC
- Power Up the Sensor

**NOTE: Always disconnect USB from PC before plugging the cable into the sensor.**

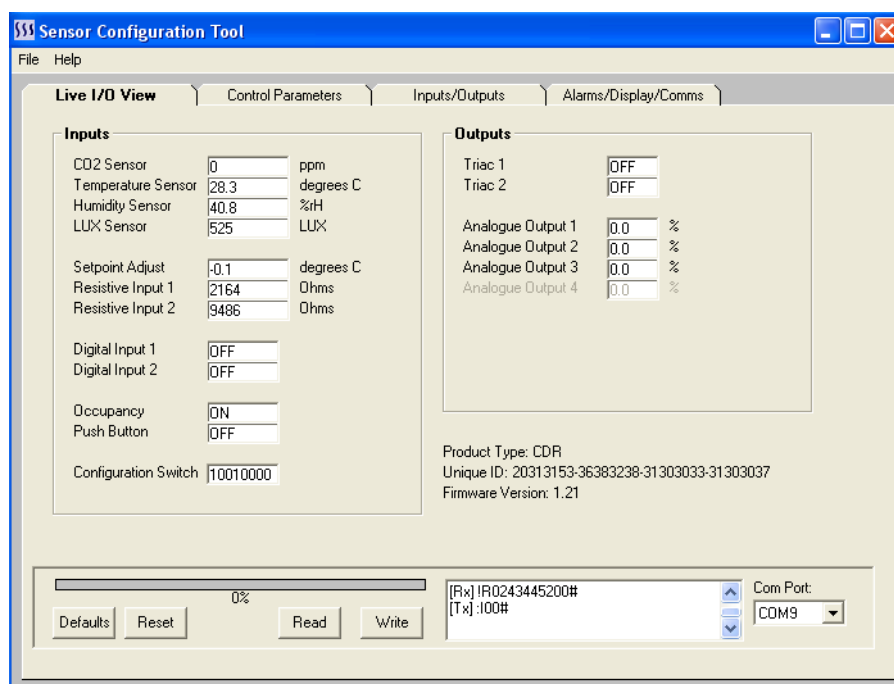

Common Parameters	
Parameter Name	Description
Defaults	Reloads the default configuration from the sensor non-volatile memory. <b>Note: All modified settings are lost.</b>
Reset	Performs soft reset of the sensor. Apply after major changes.
Read	Reads the sensor data.
Write	Writes the new settings to the sensor (automatically stored in the non-volatile memory)
COM Port	Select the COM port for the USB Cable or Bluetooth. USB cable driver must be installed in order the Serial to TTL connection to operate.

Live IO-View		
Parameter Name	Description	Range
<b>INPUTS</b>		
CO2 Sensor	CO2 Sensor Reading	Not Applicable
Temperature Sensor	Temperature Sensor Reading	0..50°C (32..122°F)
Humidity Sensor	Humidity Sensor Reading	0..100% rH
LUX Sensor	LUX Sensor Reading	Not Applicable
Setpoint Adjust	Setpoint Adjuster Reading	-500..+500
Resistive Input 1	Resistive Input 1 Reading	0..50kOhms
Resistive Input 2	Resistive Input 2 Reading	0..50kOhms
Digital Input 1	Digital Input 1 Status	Off - On
Digital Input 2	Digital Input 2 Status	Off - On
Occupancy	Occupancy Status	Not Applicable
Push Button	Push Button Status	Off - On
Configuration Switch	Bit Switch Status for Each Switch	00000000 - 11111111
<b>OUTPUTS</b>		
Triac 1	Digital Output 1	Off - On
Triac 2	Digital Output 2	Off - On
Analogue Output 1	Analogue Output 1	0..100%
Analogue Output 2	Analogue Output 2	0..100%
Analogue Output 3	Analogue Output 3	0..100%

<b>Control Parameters</b>		
<b>Parameter Name</b>	<b>Description</b>	<b>Range</b>
<b>TEMPERATURE</b>		
Temperature Loop Operating Mode	Direction of the temperature control loop.	0 = Reverse Control (Heating) 1 = Direct Control (Cooling)
Temperature Control Setpoint	Temperature Setpoint	0.0...150.0°C/°F (Default 20°C)
Temperature Proportional Band	Temperature Proportional Band	1.0...150.0°C/°F (Default 50°C)
Temperature Control Integral Action	Integral Action time of the temperature control loop. Set to 0 to disable.	0..10,000 seconds (Default 0)
Temperature Digital Output Mode Hysteresis	Hysteresis for the digital output temperature control function.	0.1...150.0°C/°F (Default 2°C)
Temperature Loop Boost Input	Boosts the Control Output to 100%	Select Push Button 1/2 or Digital Input 1/2.
<b>HUMIDITY</b>		
Humidity Loop Operating Mode	Direction of the humidity control loop.	0 = Reverse Control (Humidification) 1 = Direct Control (De-humidification)
Humidity Control Setpoint	Humidity Setpoint	0.0...100.0 %rH (Default 50%)
Humidity Proportional Band	Humidity Proportional Band	0.1...100.0 %rH (Default 20.0%)
Humidity Control Integral Action	Integral Action time of the humidity control loop. Set to 0 to disable.	0..10,000 seconds (Default 0)
Humidity Digital Output Mode Hysteresis	Hysteresis for the digital output humidity control function.	1.0...100.0 %rH (Default 5.0%)
Humidity Loop Boost Input	Boosts the Control Output to 100%	Select Push Button 1/2 or Digital Input 1/2.
<b>CO2 - NO APPLICABLE</b>		
<b>LUX - NOT APPLICABLE</b>		
<b>SETPOINT ADJUST</b>		
Setpoint Adjuster Minimum Value	Sets the minimum value for the setpoint (setpoint turned fully anti clockwise)	-500..0 (Default -3.0)
Setpoint Adjuster Maximum Value	Sets the maximum value for the setpoint (setpoint turned fully clockwise)	0..500 (Default 3.0)
Setpoint Value Influence to Control Setpoint	Setpoint Value Influence to Control Setpoint	0 = No Influence (network value) 1 = Not Applicable 2 = Temperature 3 = Humidity 4 = Lux

<b>Inputs / Outputs</b>		
<b>Parameter Name</b>	<b>Description</b>	<b>Range</b>
<b>SENSOR INPUTS</b>		
CO2 Offset	One Point CO2 Calibration Field	Not Applicable
CO2 AO Scale	Analogue Output Maximum CO2 Scaling	Not Applicable
Temperature Offset	One Point Temperature Calibration Field	-3.0..+3.0°C/°K (Default 0°C)
Temperature AO Scale	Analogue Output Maximum Temperature Scaling	0.1...150.0°C/°F (Default 50°C)
Humidity Offset	One Point Humidity Calibration Field	-5.0..+5.0 %rH (Default 0 %rH)
Humidity AO Scale	Analogue Output Humidity Maximum Scaling	0.1...100.0 %rH (Default 100.0%)
LUX AO Scale	Not Applicable	Not Applicable
Occupancy Off Delay	Not Applicable	Not Applicable
Push Button Off Delay	Delay Time Setting for Push Button	1..7200 Seconds (Default 600s)
DI1 Off Delay	Delay Time Setting for Digital Input 1	0..7200 Seconds (Default 0s)
DI2 Off Delay	Delay Time Setting for Digital Input 2	0..7200 Seconds (Default 0s)

**OUTPUTS**



Inputs / Outputs		
Parameter Name	Description	Range
AO1 (Y1)	Analogue Output Y1 Mode	0 = Network Value 1 = Not Applicable 2 = Temperature Measurement 3 = Humidity Measurement (Default) 4 = Not Applicable (LUX) 5 = Not Applicable 6 = Temperature Control 7 = Humidity Control 8 = Not Applicable 9 = Not Applicable
AO2 (Y2)	Analogue Output Y2 Mode	0 = Network Value 1 = Not Applicable 2 = Temperature Measurement (Default) 3 = Humidity Measurement 4 = Not Applicable (LUX) 5 = Not Applicable 6 = Temperature Control 7 = Humidity Control 8 = Not Applicable
AO3 (Y3)	Analogue Output Y3 Mode	0 = Network Value 1 = Not Applicable 2 = Temperature Measurement 3 = Humidity Measurement 4 = Not Applicable (LUX) 5 = Not Applicable 6 = Temperature Control 7 = Humidity Control 8 = Not Applicable
DO1	Digital Output 1 Mode	0 = Network Value (Default) 1 = Not Applicable 2 = Temperature Relay 3 = Humidity Relay 4 = Not Applicable 5 = Not Applicable 6 = Push Button
DO2	Digital Output 2 Mode	0 = Network Value (Default) 1 = Not Applicable 2 = Temperature Relay 3 = Humidity Relay 4 = Not Applicable 5 = Not Applicable 6 = Push Button

Alarm/Display/Comms		
Parameter Name	Description	Range
<b>ALARMS - NOT APPLICABLE</b>		
<b>DISPLAY</b>		
Temperature Units	Temperature Unit Selection	0 = Celsius (Default) 1 = Fahrenheit
Display Mode	Display Mode	0 = Rotate Installed 1 = Not Applicable 2 = Temperature Only 3 = Not Applicable
LCD brightness	Brightness of the LCD	Off - 10% to 100%
<b>COMMS</b>		
M-Bus Baud Rate NOTE: Does not show M-Bus Baud Rate set via bit switches.	M-Bus Baud Rate (can only be set if BR1 and BR2 are in OFF position)	0 = 300 1 = 2400 (Default) 2 = 9600
Address NOTE: Does not show Modbus address set via bit switches.	M-Bus Address (can only be set if all address bit switches are in OFF position)	0..247 (Default 0)

**Parameter Storage**

The configuration parameters are stored in the non-volatile memory. The DCT (Sensor Configuration Tool) software will automatically store the register values on the non-volatile permanent memory after the changes are carried out.

**Setting Up M-Bus Primary Address and Baud Rate**

The RHR M-Bus address and the baud rate is normally set through the bit switch. It is also possible to set the address and baud rate over the configuration tool.

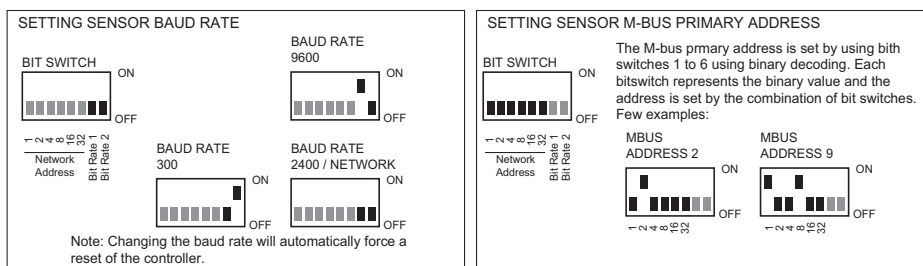

**M-Bus Implementation (EN1434-3)**

The RHR-MBUS sensors support M-bus baud rates 300, 2400 and 9600 bps. The baud rate speeds can be selected using the built-in bit switch, or via the SW-DCT-USB tool if BR1 and BR2 are set to OFF. The sensor primary addresses 1 to 63 can be set using the local bit switch.

Secondary addressing is supported with wildcards. Secondary address is fixed and set to the product serial number.

SND\_NKE/E5, SND\_UD/E5, REQ\_UD2/RSP\_UD messages are supported.

**Read Data from Sensor (REQ UD2/ RSP UD)**

All telegram contents are shown in hexadecimal.

Fields assigned with "xx" are variable.

Telegrams received by the Sensor/Controller are shown with a pink header

Telegrams transmitted by the Sensor/Controller are shown with a blue header.

All data fields report instantaneous values.

Telegram Field	Parameter Description	Data Format	M-BUS VIF Type	Scaling	Notes:
1	Digital Output Status	8-Bit Integer	Digital Outputs		Bit 0 = DO1 Bit 1 = DO2 Bit 2 = 0 Bit 3 = 0 Bit 4 = 0 Bit 5 = 0 Bit 6 = 0 Bit 7 = 0
2	AO1	16-Bit Integer	Dimensionless	x10	0.0...100.0%
3	AO2	16-Bit Integer	Dimensionless	x10	0.0...100.0%
4	AO3	16-Bit Integer	Dimensionless	x10	0.0...100.0%
5	AO4	16-Bit Integer	Dimensionless	x10	0.0...100.0%
6	DI1 Pulse Count	32-Bit Integer	Dimensionless		0...2147483648
7	DI2 Pulse Count	32-Bit Integer	Dimensionless		0...2147483648
8	DI Status	8-Bit Integer	Digital Inputs		Bit 0 = DI1 Bit 1 = DI2 Bit 2 = Occupancy Bit 3 = Re Alarm Bit 4 = Push Button 1 Bit 5 = Push Button 2 Bit 6 = Push Button 3 Bit 7 = Push Button 4
9	NTC10	16-Bit Integer	External Temperature	x10	-40.0..150.0
10	Humidity	16-Bit Integer	Dimensionless	x10	0.0...100.0%
11	CO2	16-Bit Integer	Not Applicable		Not Applicable
12	RI1 (NTC)	16-Bit Integer	External Temperature	x10	-40.0..150.0
13	RI1 (Ohms)	16-Bit Integer	Dimensionless		0..1,000,000 Ohms
14	RI2 (NTC)	16-Bit Integer	External Temperature	x10	-40.0..150.0

Telegram Field	Parameter Description	Data Format	M-BUS VIF Type	Scaling	Notes:
15	RI2 (Ohms)	16-Bit Integer	Dimensionless		0..1,000,000 Ohms

1	2	3	4	5
Start	C	A	CS	Stop
10	7B/5B	xx	xx	16

1	2	3	4	5	6	7
Start	Length	Length	Start	C	A	CI
68	63	63	68	08	xx	72

**Long Frame Header**

8	9	10	11	12	13	14	15	16	17	18	19
ID <sub>0</sub>	ID <sub>1</sub>	ID <sub>2</sub>	ID <sub>3</sub>	Man <sub>0</sub>	Man <sub>1</sub>	Gen	Med	TC	Status	Sig <sub>0</sub>	Sig <sub>1</sub>
xx	xx	xx	xx	38	4F	01	00	xx	00	00	00

**Fixed Data Header**

20	21	22	23
DIF	VIF	VIFE	Data
01	FD	1A	xx

**Field 1: DO\_States**

24	25	26	27	28	29	30	31	32	33	34	35
DIF	VIF	VIFE	VIFE	Data	Data	DIF	VIF	VIFE	VIFE	Data	Data
02	FD	BA	75	xx	xx	02	FD	BA	75	xx	xx

**Field 2: AO1****Field 3: AO2**

36	37	38	39	40	41	42	43	44	45	46	47
DIF	VIF	VIFE	VIFE	Data	Data	DIF	VIF	VIFE	VIFE	Data	Data
02	FD	BA	75	xx	xx	02	FD	BA	75	xx	xx

**Field 4: AO3****Field 5: AO4**

48	49	50	51	52	53	54
DIF	VIF	VIFE	Data	Data	Data	Data
04	FD	3A	xx	xx	xx	xx

**Field 6: DI1 PulseCount**

55	56	57	58	59	60	61	62	63	64	65
DIF	VIF	VIFE	Data	Data	Data	Data	DIF	VIF	VIFE	Data
04	FD	3A	xx	xx	xx	xx	01	FD	1B	xx

**Field 7: DI2 PulseCount****Field 8: DI\_States**

66	67	68	69	70	71	72	73	74	75
DIF	VIF	Data	Data	DIF	VIF	VIFE	VIFE	Data	Data
02	66	xx	xx	02	FD	BA	75	xx	xx

**Field 9: NTC10****Field 10: Humidity**

76	77	78	79	80	81	82	83	84
DIF	VIF	VIFE	Data	Data	DIF	VIF	Data	Data
02	FD	3A	xx	xx	02	66	xx	xx

**Field 11: Not Applicable****Field 12: RI1 (NTC10)**

85	86	87	88	89	90	91	92	93	94	95
DIF	VIF	VIFE	Data	Data	Data	Data	DIF	VIF	Data	Data
04	FD	3A	xx	xx	xx	xx	02	66	xx	xx

**Field 13: RI1 (Ohms)****Field 14: RI2 (NTC10)**

96	97	98	99	100	101	102	103	104	105
DIF	VIF	VIFE	Data	Data	Data	Data	EOT	CS	STOP
04	FD	3A	xx	xx	xx	xx	0F	xx	16

**Field 15: RI2 (Ohms)****End Telegram****Configuration with SND\_UD**

The following data fields can be written to by sending a SND\_UD telegram to the controller with adjusted data field values:

- DO Status,
- AO1,
- AO2,
- AO3,
- AO4,
- DI1 Pulse Count,
- DI2 Pulse Count

In the case of the Digital Outputs and Analog Outputs (DO, AO) the values written will be applied to the physical outputs if the controller/sensor has been configured such that the associated outputs are assigned to a 'network' function rather than a control function

1	2	3	4	5	6	7
Start	Length	Length	Start	C	A	Cl
68	57	57	68	53	xx	51
<b>Long Frame Header</b>						

8	9	10	11
DIF	VIF	VIFE	Data
01	FD	1A	Xx
<b>Field 1: DO Status</b>			

12	13	14	15	16	17	18	19	20	21	22	23
DIF	VIF	VIFE	VIFE	Data	Data	DIF	VIF	VIFE	VIFE	Data	Data
02	FD	BA	75	xx	xx	02	FD	BA	75	xx	Xx
<b>Field 2: AO1</b>						<b>Field 3: AO2</b>					

24	25	26	27	28	29	30	31	32	33	34	35
DIF	VIF	VIFE	VIFE	Data	Data	DIF	VIF	VIFE	VIFE	Data	Data
02	FD	BA	75	xx	xx	02	FD	BA	75	xx	xx
<b>Field 4: AO3</b>						<b>Field 5: AO4</b>					

36	37	38	39	40	41	42
DIF	VIF	VIFE	Data	Data	Data	Data
04	FD	3A	xx	xx	xx	xx
<b>Field 6: DI1 PulseCount</b>						

43	44	45	46	47	48	49	50	51	52	53
DIF	VIF	VIFE	Data	Data	Data	Data	DIF	VIF	VIFE	Data
04	FD	3A	xx	xx	xx	xx	01	FD	1B	Xx
<b>Field 7: DI2 PulseCount</b>						<b>Field 8: DI Status</b>				

54	55	56	57	58	59	60	61	62	63
DIF	VIF	Data	Data	DIF	VIF	VIFE	VIFE	Data	Data
02	66	xx	xx	02	FD	BA	75	xx	xx
<b>Field 9: NTC10</b>					<b>Field 10: Humidity</b>				

64	65	66	67	68	69	70	71	71
DIF	VIF	VIFE	Data	Data	DIF	VIF	Data	Data
02	FD	3A	xx	xx	02	66	xx	xx
<b>Field 11: Not Applicable</b>					<b>Field 12: RI1 (NTC10)</b>			

73	74	75	76	77	78	79	80	81	82	83
DIF	VIF	VIFE	Data	Data	Data	Data	DIF	VIF	Data	Data
04	FD	3A	xx	xx	xx	xx	02	66	xx	xx
<b>Field 13: RI1 (Ohms)</b>						<b>Field 14: RI2 (NTC10)</b>				

84	85	86	87	88	89	90
DIF	VIF	VIFE	Data	Data	Data	Data
04	FD	3A	xx	xx	xx	Xx
<b>Field 15: RI2 (Ohms)</b>						

91	92	93
EOT	CS	STOP
0F	xx	16
<b>End Telegram</b>		

1
ACK
E5

Note: Data written to fields 8-15 will be ignored.

#### Set All Changeable Parameters Only

1	2	3	4	5	6	7
Start	Length	Length	Start	C	A	Cl
68	2E	2E	68	53	xx	51
<b>Long Frame Header</b>						

8	9	10	11
DIF	VIF	VIFE	Data
01	FD	1A	Xx
<b>DO Status</b>			

<b>12</b>	<b>13</b>	<b>14</b>	<b>15</b>	<b>16</b>	<b>17</b>	<b>18</b>	<b>19</b>	<b>20</b>	<b>21</b>	<b>22</b>	<b>23</b>
DIF	VIF	VIFE	VIFE	Data	Data	DIF	VIF	VIFE	VIFE	Data	Data
02	FD	BA	75	xx	xx	02	FD	BA	75	xx	Xx
<b>AO1</b>						<b>AO2</b>					

<b>24</b>	<b>25</b>	<b>26</b>	<b>27</b>	<b>28</b>	<b>29</b>	<b>30</b>	<b>31</b>	<b>32</b>	<b>33</b>	<b>34</b>	<b>35</b>
DIF	VIF	VIFE	VIFE	Data	Data	DIF	VIF	VIFE	VIFE	Data	Data
02	FD	BA	75	xx	xx	02	FD	BA	75	xx	Xx
<b>AO3</b>						<b>AO4</b>					

<b>36</b>	<b>37</b>	<b>38</b>	<b>39</b>	<b>40</b>	<b>41</b>	<b>42</b>
DIF	VIF	VIFE	Data	Data	Data	Data
04	FD	3A	xx	xx	xx	Xx
<b>DI2 PulseCount</b>						

<b>43</b>	<b>44</b>	<b>45</b>	<b>46</b>	<b>47</b>	<b>48</b>	<b>49</b>
DIF	VIF	VIFE	Data	Data	Data	Data
04	FD	3A	xx	xx	xx	Xx
<b>DI2 PulseCount</b>						

<b>50</b>	<b>51</b>	<b>52</b>
EOT	CS	STOP
0F	xx	16
<b>End Telegram</b>		

<b>1</b>
ACK
E5

**Set Digital Outputs Only**

<b>1</b>	<b>2</b>	<b>3</b>	<b>4</b>	<b>5</b>	<b>6</b>	<b>7</b>
Start	Length	Length	Start	C	A	Cl
68	08	08	68	53	xx	51
<b>Long Frame Header</b>						

<b>8</b>	<b>9</b>	<b>10</b>	<b>11</b>
DIF	VIF	VIFE	Data
01	FD	1A	Xx
<b>DO Status</b>			

<b>12</b>	<b>13</b>	<b>14</b>
EOT	CS	STOP
0F	xx	16
<b>End Telegram</b>		

<b>1</b>
ACK
E5

**Set Analogue Outputs Only**

<b>1</b>	<b>2</b>	<b>3</b>	<b>4</b>	<b>5</b>	<b>6</b>	<b>7</b>
Start	Length	Length	Start	C	A	Cl
68	1C	1C	68	53	xx	51
<b>Long Frame Header</b>						

<b>8</b>	<b>9</b>	<b>10</b>	<b>11</b>	<b>12</b>	<b>13</b>	<b>14</b>	<b>15</b>	<b>16</b>	<b>17</b>	<b>18</b>	<b>19</b>
DIF	VIF	VIFE	VIFE	Data	Data	DIF	VIF	VIFE	VIFE	Data	Data
02	FD	BA	75	xx	xx	02	FD	BA	75	xx	Xx
<b>AO1</b>						<b>AO2</b>					

<b>20</b>	<b>21</b>	<b>22</b>	<b>23</b>	<b>24</b>	<b>25</b>	<b>26</b>	<b>27</b>	<b>28</b>	<b>29</b>	<b>30</b>	<b>31</b>
DIF	VIF	VIFE	VIFE	Data	Data	DIF	VIF	VIFE	VIFE	Data	Data
02	FD	BA	75	xx	xx	02	FD	BA	75	xx	Xx
<b>AO3</b>						<b>AO4</b>					

<b>32</b>	<b>33</b>	<b>34</b>
EOT	CS	STOP
0F	xx	16
<b>End Telegram</b>		

<b>1</b>
ACK

E5

**Set Pulse Counts**

1	2	3	4	5	6	7
Start	Length	Length	Start	C	A	Cl
68	12	12	68	53	xx	51
<b>Long Frame Header</b>						

8	9	10	11	12	13	14
DIF	VIF	VIFE	Data	Data	Data	Data
04	FD	3A	xx	xx	xx	Xx
<b>DI2 PulseCount</b>						

15	16	17	18	19	20	21
DIF	VIF	VIFE	Data	Data	Data	Data
04	FD	3A	xx	xx	xx	Xx
<b>DI2 PulseCount</b>						

22	23	24
EOT	CS	STOP
0F	xx	16
<b>End Telegram</b>		

1
ACK
E5

**Selection for secondary addressing**

1	2	3	4	5	6	7
Start	Length	Length	Start	C	A	Cl
68	0B	0B	68	53	FD	52
<b>Secondary Address Selection</b>						

8	9	10	11	12	13	14	15	16	17
ID <sub>0</sub>	ID <sub>1</sub>	ID <sub>2</sub>	ID <sub>3</sub>	Man <sub>0</sub>	Man <sub>1</sub>	Gen	Med	CS	Stop
xx	xx	xx	xx	38	5F	01	00	xx	16

1
ACK
E5

The ACK is only sent if the selection criteria matches that of the sensor.

**Application Reset**

1	2	3	4	5	6	7	8	9
Start	Length	Length	Start	C	A	Cl	CS	Stop
68	03	03	68	53	xx	50	xx	16
<b>Application Reset</b>								

1
ACK
E5

Or

1	2	3	4	5	6	7	8	9	10
Start	Length	Length	Start	C	A	Cl	Sub	CS	Stop
68	03	03	68	53	xx	50	xx	xx	16
<b>Application Reset + reset subcode</b>									

1
ACK
E5

**Dimensions**

